

**HEAT SINK**

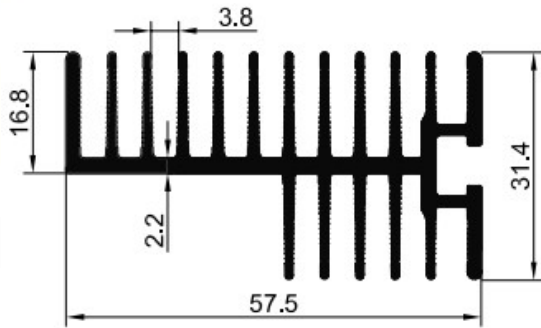

SI NO	SECTION NO.	WEIGHT(KG/M)
1	8901	1.282

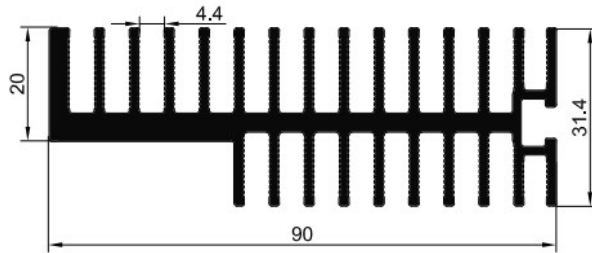

SI NO	SECTION NO.	WEIGHT(KG/M)
1	8903	2.549

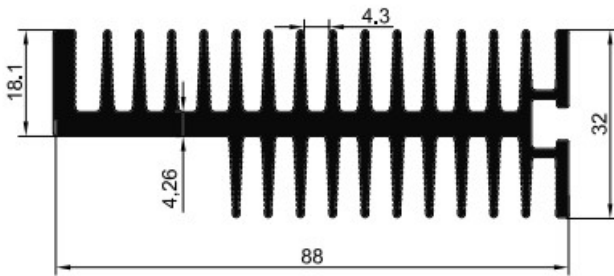

SI NO	SECTION NO.	WEIGHT(KG/M)
1	8905	2.706

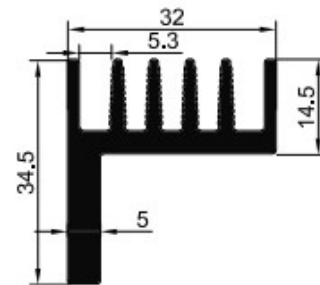

SI NO	SECTION NO.	WEIGHT(KG/M)
1	8907	0.905

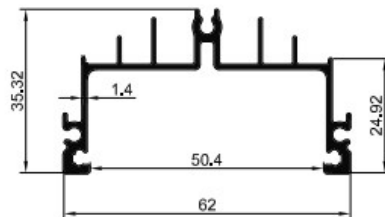

SI NO	SECTION NO.	WEIGHT(KG/M)
1	8909	0.626

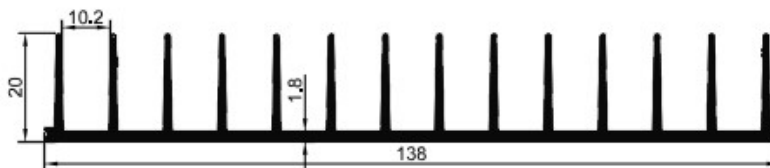

SI NO	SECTION NO.	WEIGHT(KG/M)
1	8917	1.465



SI NO	SECTION NO.	WEIGHT(KG/M)
1	8919	2.533

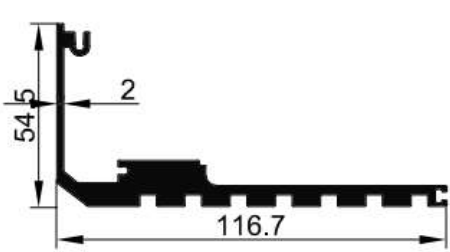

SI NO	SECTION NO.	WEIGHT(KG/M)
1	8921	2.419

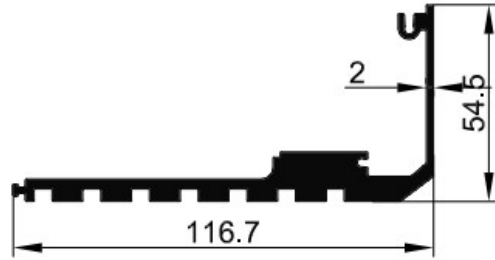

SI NO	SECTION NO.	WEIGHT(KG/M)
1	8923	2.418

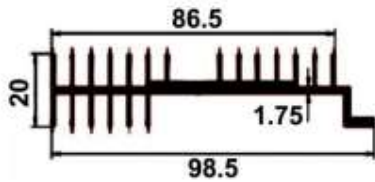

SI NO	SECTION NO.	WEIGHT(KG/M)
1	9001	2.419

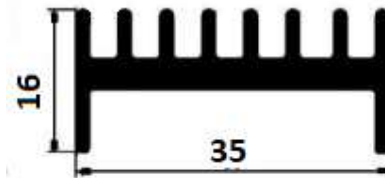

SI NO	SECTION NO.	WEIGHT(KG/M)
1	9003	0.560

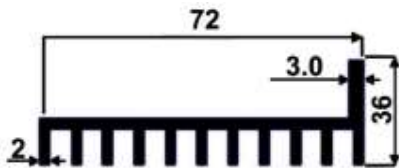

SI NO	SECTION NO.	WEIGHT(KG/M)
1	9005	1.652

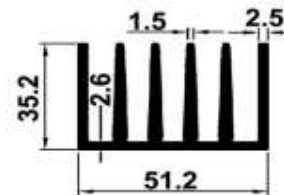

SI NO	SECTION NO.	WEIGHT(KG/M)
1	9008	1.727

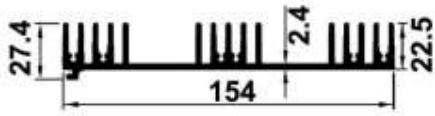

SI NO	SECTION NO.	WEIGHT(KG/M)
1	9009	2.677

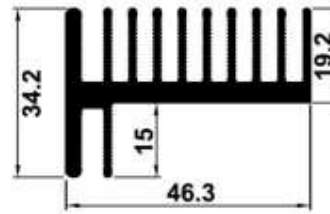

SI NO	SECTION NO.	WEIGHT(KG/M)
1	9010	1.242

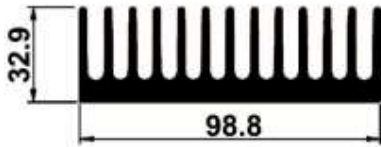

SI NO	SECTION NO.	WEIGHT(KG/M)
1	9012	4.069

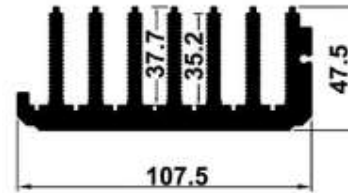

SI NO	SECTION NO.	WEIGHT(KG/M)
1	9016	6.121

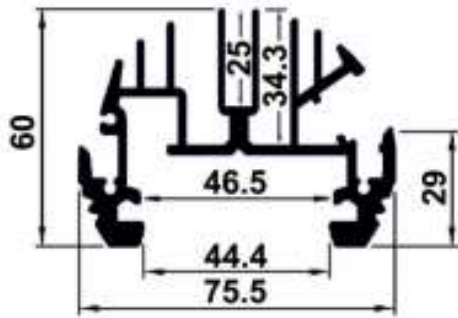

SI NO	SECTION NO.	WEIGHT(KG/M)
1	9018	2.203

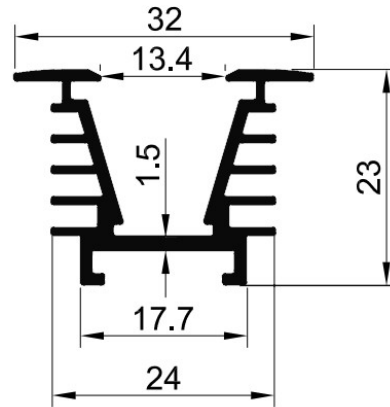

SI NO	SECTION NO.	WEIGHT(KG/M)
1	9015	0.381

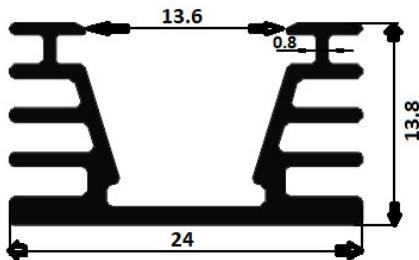

SI NO	SECTION NO.	WEIGHT(KG/M)
1	9014	0.281

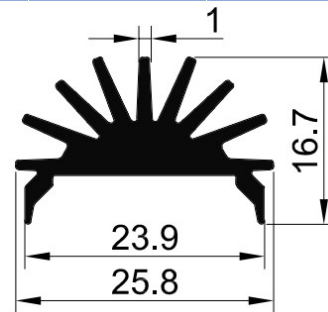

SI NO	SECTION NO.	WEIGHT(KG/M)
1	8925	0.420

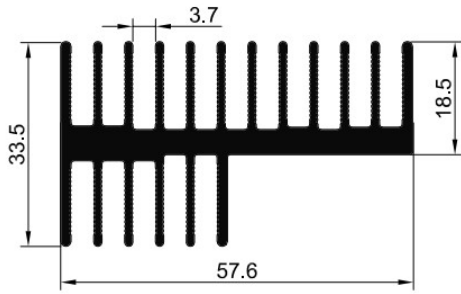

SI NO	SECTION NO.	WEIGHT(KG/M)
1	8933	1.605

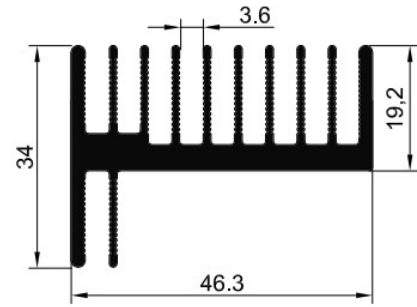

SI NO	SECTION NO.	WEIGHT(KG/M)
1	8935	1.157

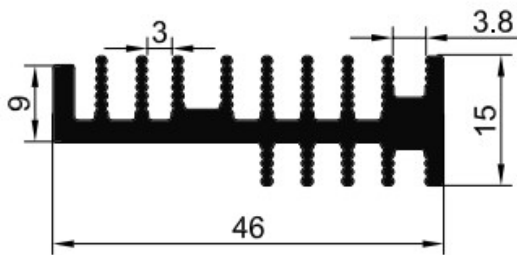

SI NO	SECTION NO.	WEIGHT(KG/M)
1	8929	0.734

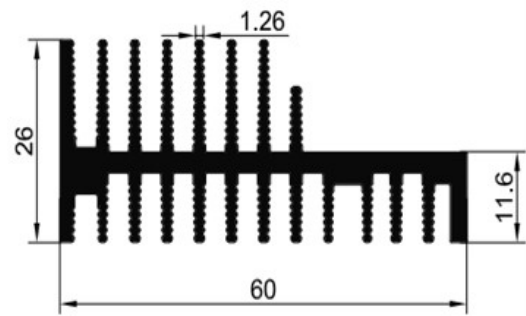

SI NO	SECTION NO.	WEIGHT(KG/M)
1	8931	1.367